

30

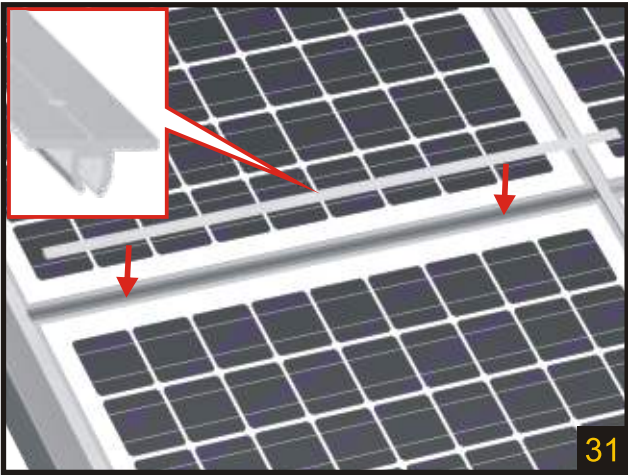

31

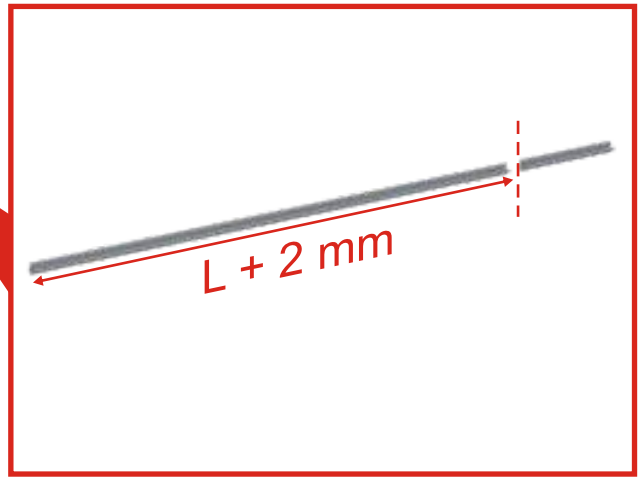
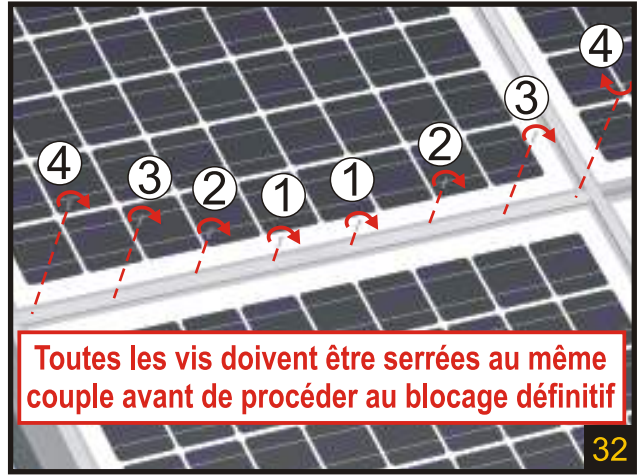

32

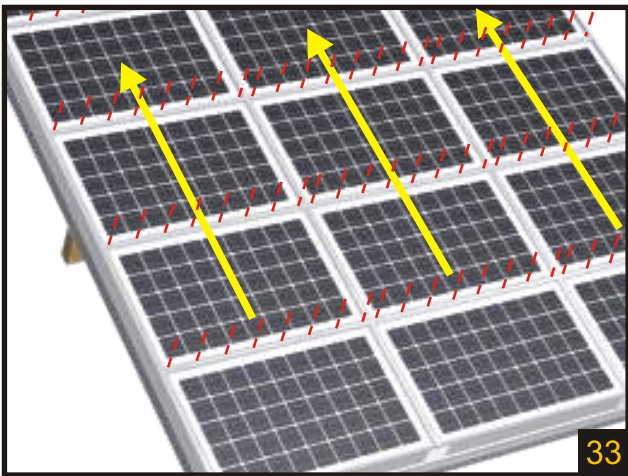

33

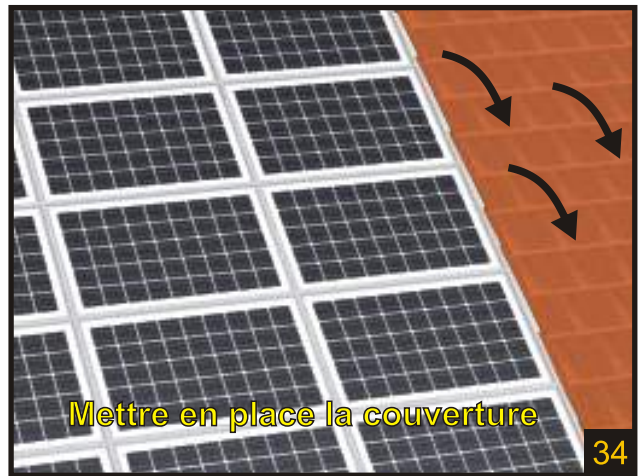

34



35

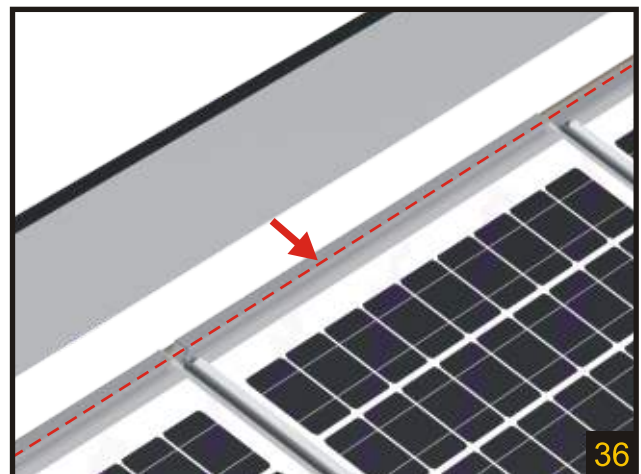

36

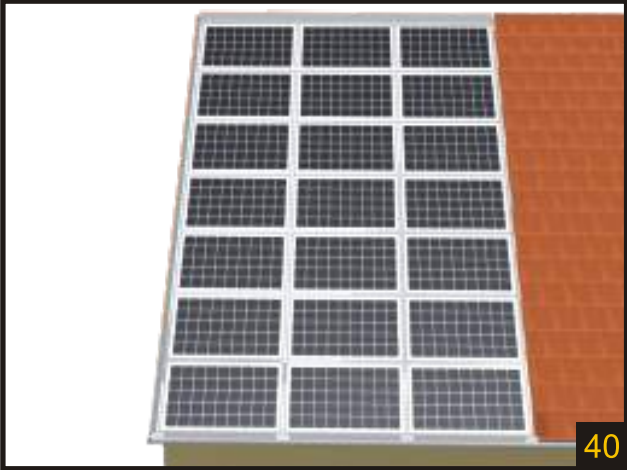
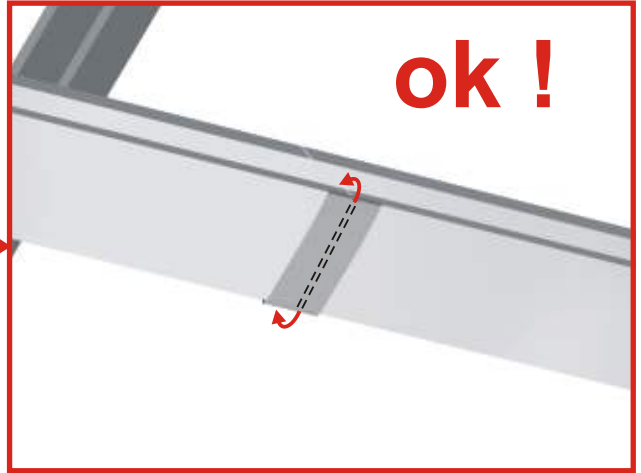
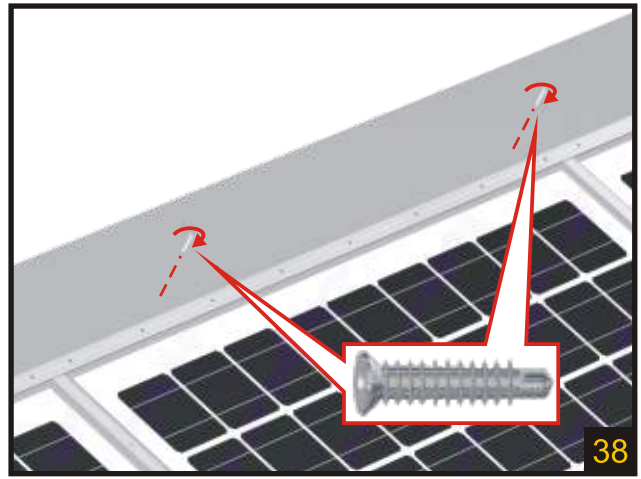
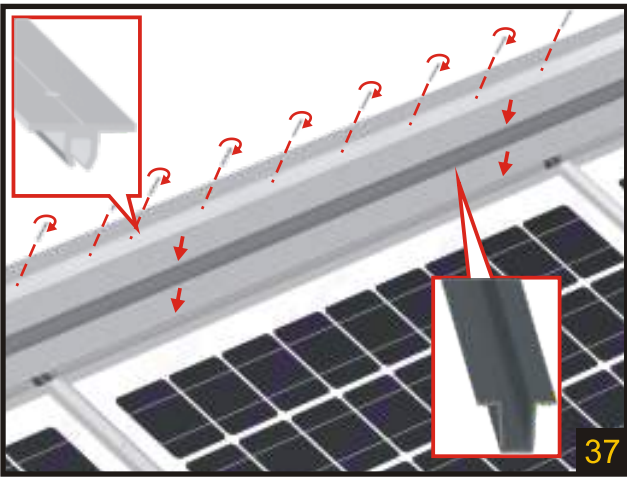

**JMA SOL**  
Un client Un projet Une solution

**Corn-Ar-Hoat  
F-29150 CAST  
www.jma-sol.com**